

Geçiş ölçüsü

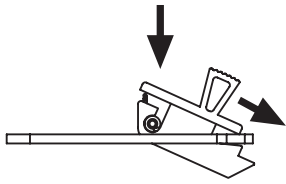

KAPI KALINLIĞI	
Min	Max
0.8mm	1.5mm

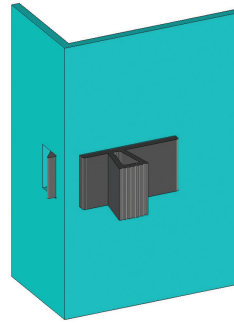
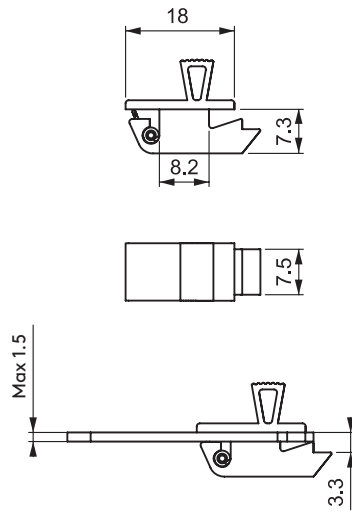

171

MINİ SÜRGÜ KİLİT



- Panoların küçük boyutlu iç kapaklarında kullanılır .
- Sac kalınlığı 0.8 mm-1.5 mm arasındadır.

MALZEME

GÖVDE: ABS

YAY: Paslanmaz çelik

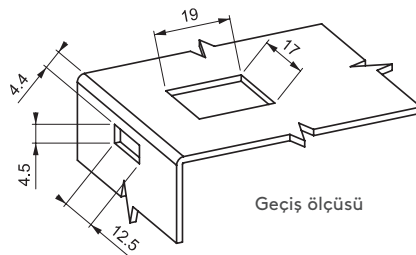
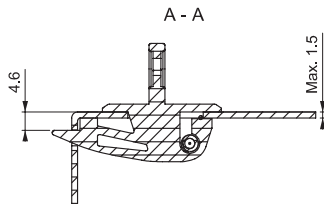
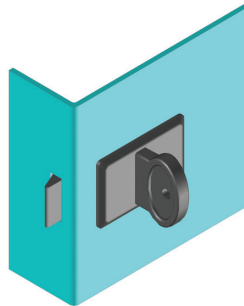
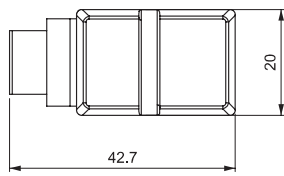
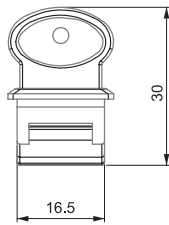
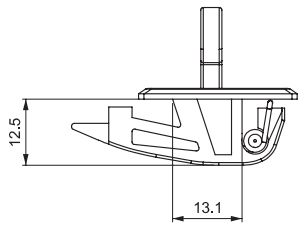

471

MINİ SÜRGÜ KİLİT



- Panoların küçük boyutlu iç kapaklarında kullanılır .
- Sac kalınlığı 0.8 mm-1.5 mm arasındadır.

MALZEME

GÖVDE: ABS

YAY: Paslanmaz çelik