

İSPANYOLET SİSTEMLİ KİLİTLER

İSPANYOLET SİSTEMLİ KOLLU KİLİT

909

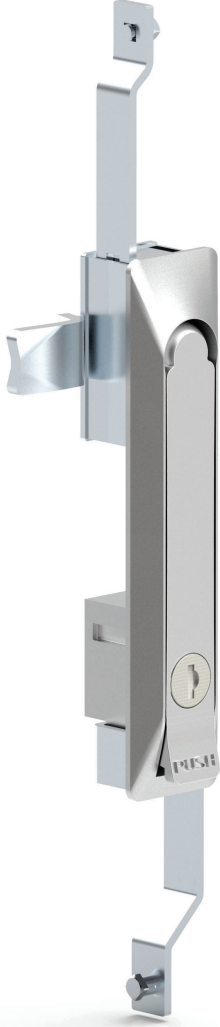

RoHS



IP 65



L | R

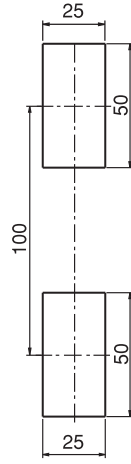

Geçiş Ölçüsü

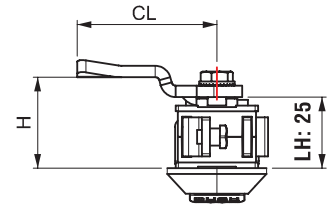
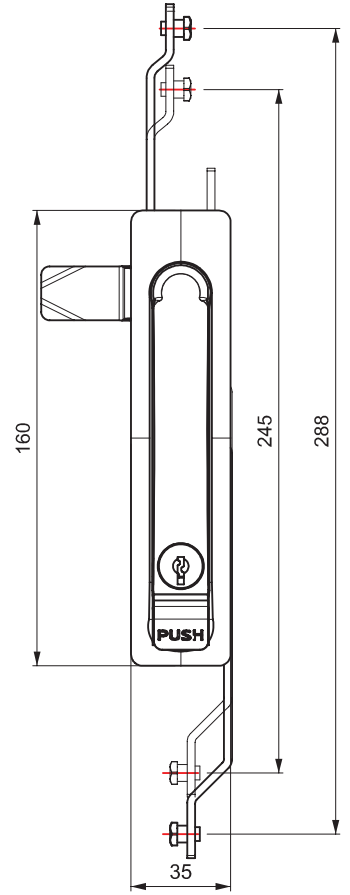
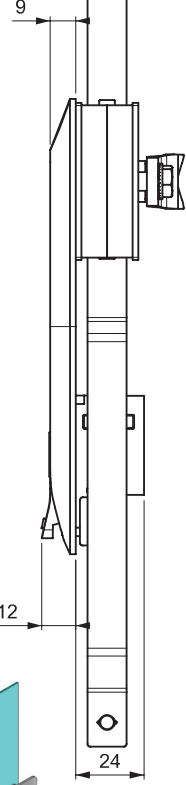
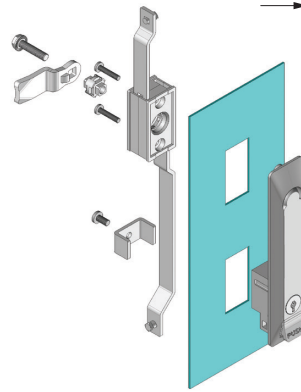

- Basmalı tip kollu kilit
- Özel renkler için Mesan ile iletişime geçiniz.
- Kolda yay uygulaması vardır.

MALZEME

GÖVDE Zamak DIN-EN 774-ZnAl4Cu1 or PA6 GFR 30
MEKANİZMA: Zamak DIN-EN 1774-ZnAl4Cu1
KOL Zamak DIN-EN 1774-ZnAl4Cu1
DİL: Çelik
CONTA: Poliüretan

ÜRÜN KODU

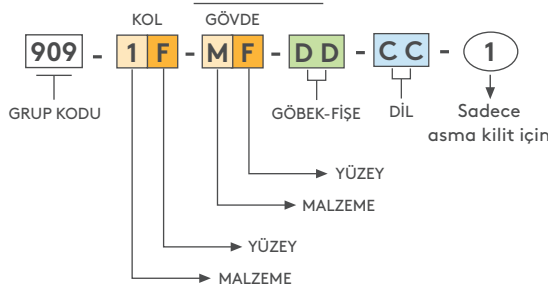

MALZEME

MALZEME	M
Zamak	1
Plastik	2

YÜZEY

YÜZEY	F
Krom kaplama	1
Siyah boya	2
Kaplamasız	0

YÜKSEK GÜVENLİKLİ BAREL



Aynı şifre

Farklı şifre

GÖBEKLER

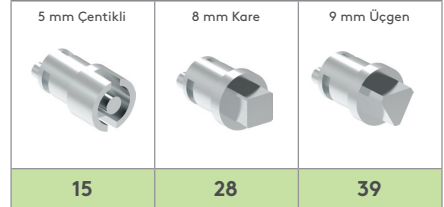

5 mm Çentikli

8 mm Kare

9 mm Üçgen

SİLİNDİR - FİŞE

SİLİNDİR - FİŞE	DD
Silindirsiz - fişesiz	00
Aynı şifre (Paslanmaz toz kapaklı fişe)	03
Farklı şifre (Paslanmaz toz kapaklı fişe)	32
Master Sistem	04
Euro key (5333)	05
CH751 (Paslanmaz toz kapaklı fişe)	07



Diller için Sayfa: 172 - 173



Çubuk ve lamalar için Sayfa: 178 - 188



Anahtarlar için Sayfa: 189 - 191